

ARTI TYP 2

Art.-Nr.

403 336
403 337
403 338
403 339

600
650
384
mm

1/6
VO
50-2024

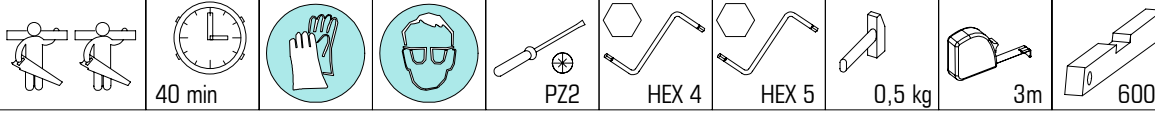



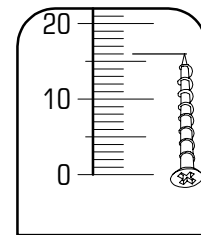
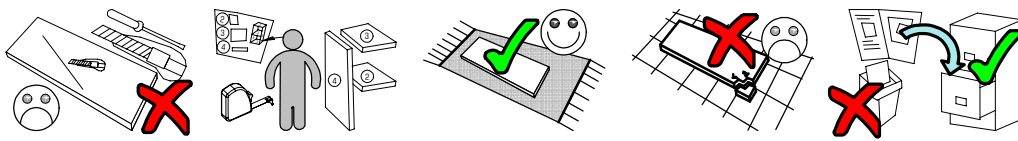
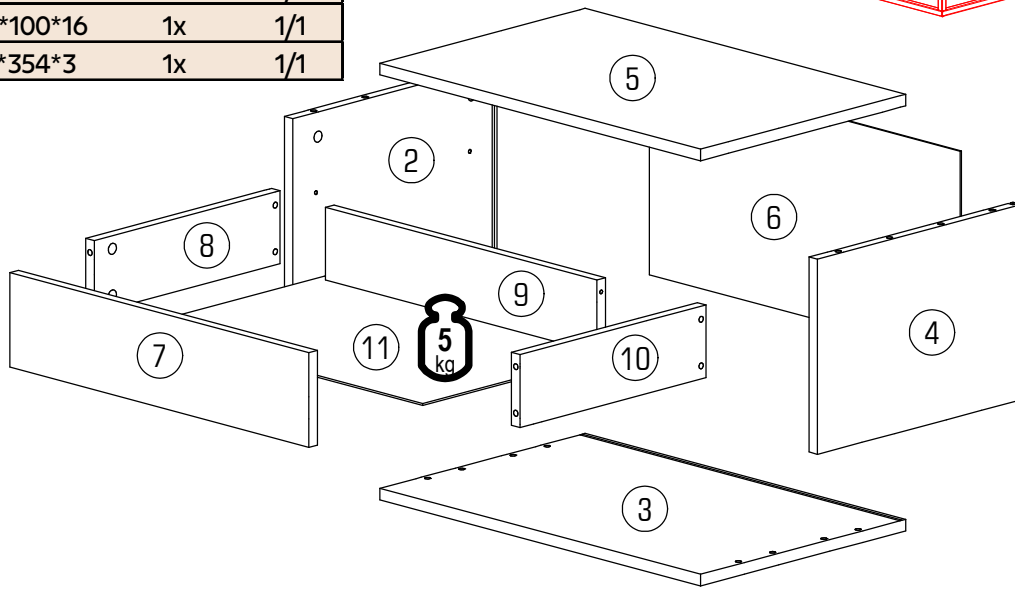
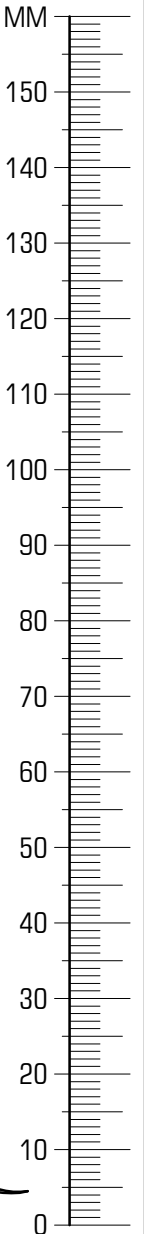
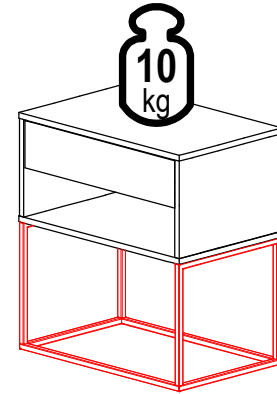

ID	ID			
21856	②	268*382*16	1x	1/1
21863	③	600*384*16	1x	1/1
21858	④	268*382*16	1x	1/1
21864	⑤	600*384*16	1x	1/1
21865	⑥	582*284*3	1x	1/1
21866	⑦	560*130*16	1x	1/1
21875	⑧	348*100*16	1x	1/1
13672	⑨	508*100*16	1x	1/1
21876	⑩	348*100*16	1x	1/1
10113	⑪	538*354*3	1x	1/1

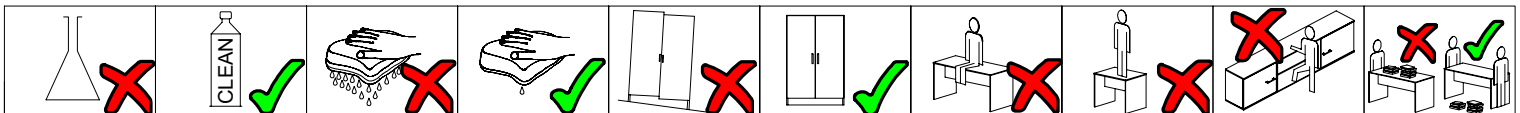

27000.00		Ø8x30	22300.00		Ø7x50	22800.01		HEX 4	22244.01		Ø3,5x16	22243.00		Ø3,5x15	22705.00		Ø6,8x8	34800.00		Ø 12
A	8x		B	4x		C	1x		D	8x		E	8x		F	4x		G	4x	
22256.00		Ø5,0x70	33006.01		L=350	70013.01		Ø15x13	70021.01						33006.01		L=350	22305.02		Ø7x60
H	1x		J	1x		K	8x		L	8x			M	4x		N	1x		P	4x
24101.00		Ø10	81103.00			24101.00			81103.00			22800.01		HEX 5			M6x16			
Q	1x		R	1x		S	2x		T	1x		U	1x		V	4x				

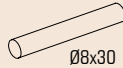

2/6 ARTI TYP 2

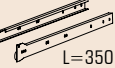
				
A	E	F	K	J
8x	2x	4x	4x	1x
				L=350

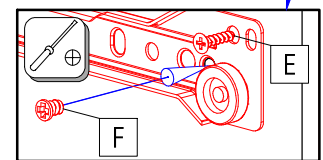
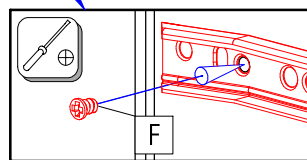
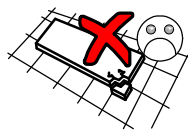
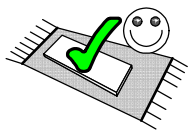
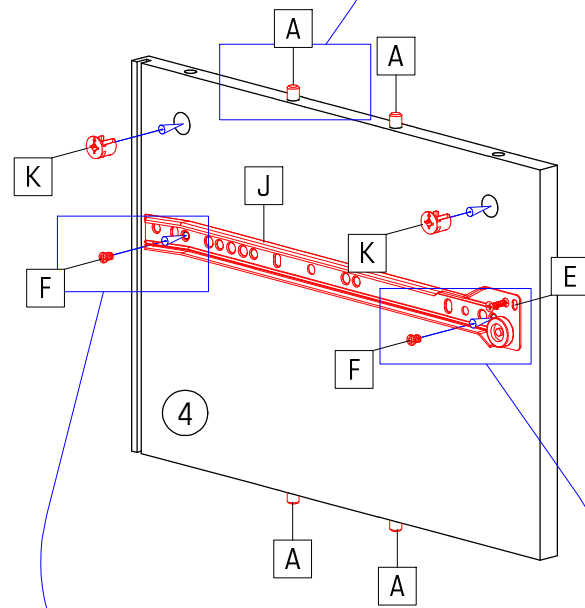
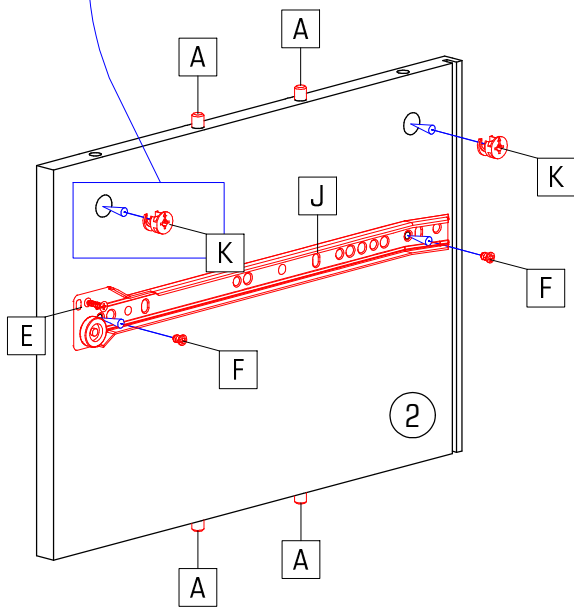
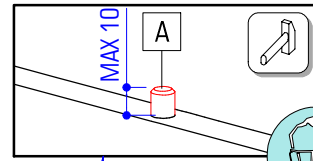
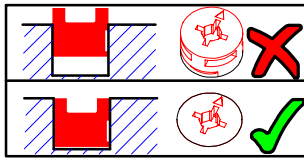
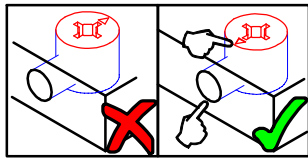
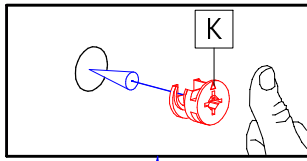
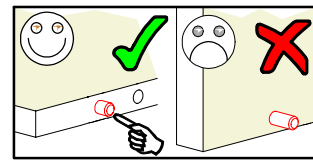

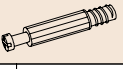

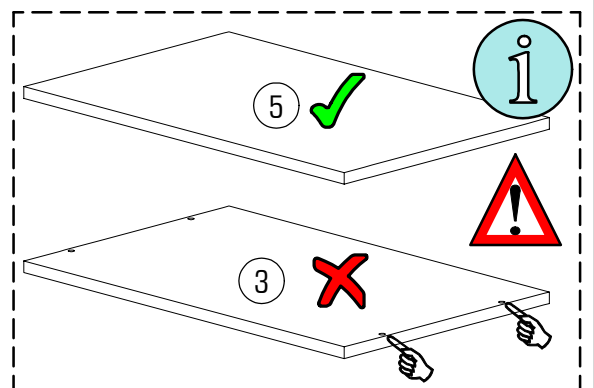
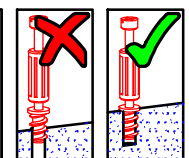
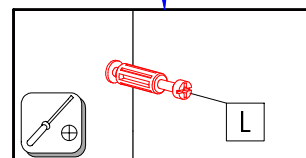
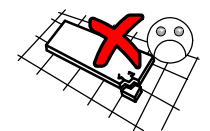
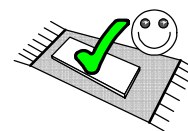
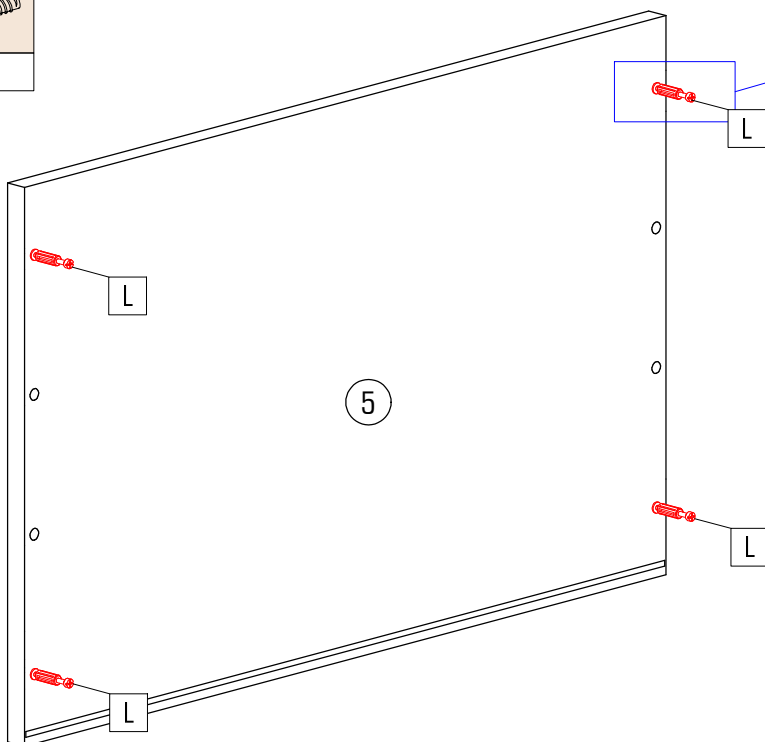
L
4x

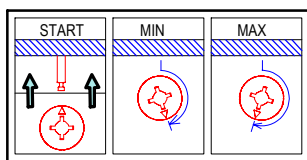
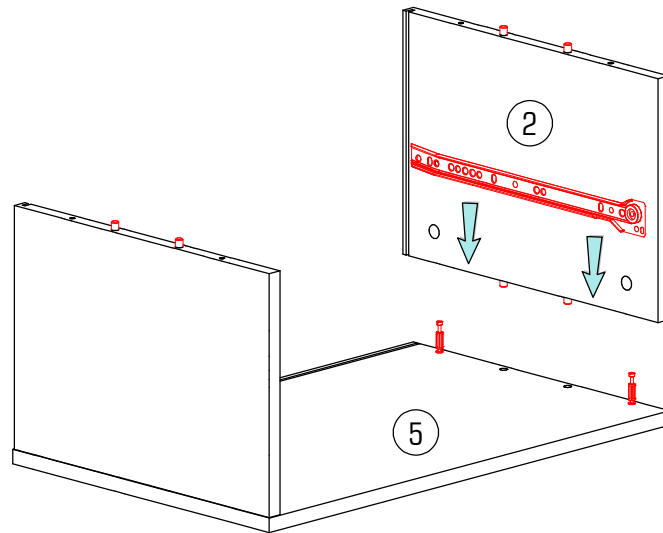
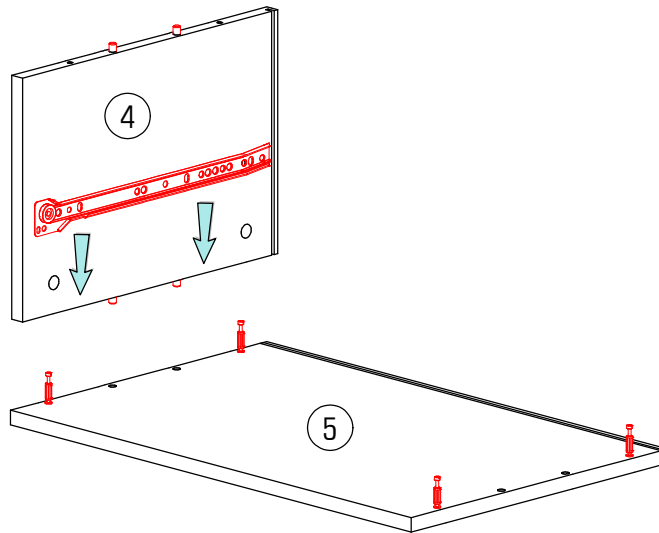



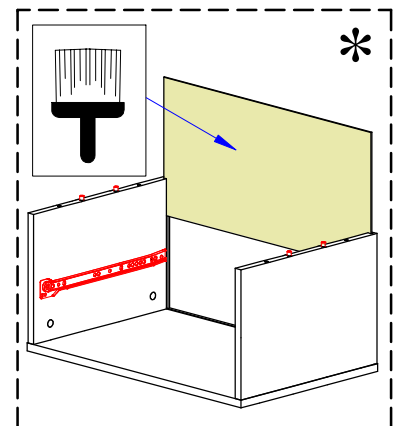
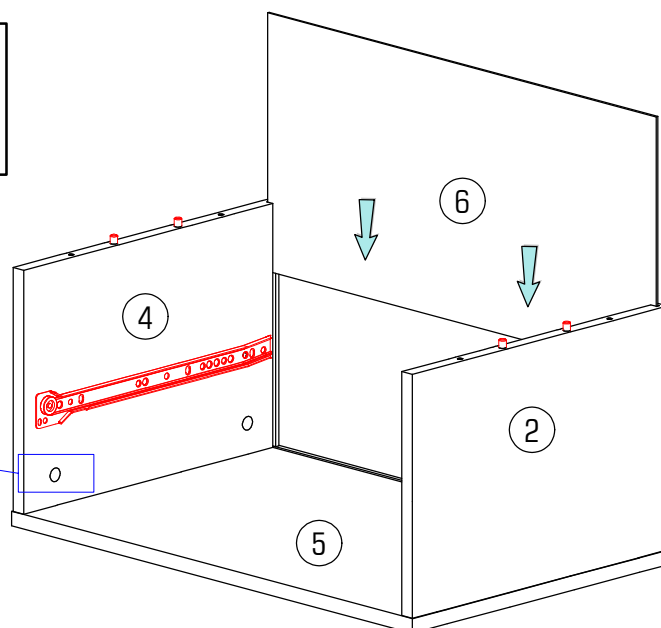



4x



4/6 ARTI TYP 2



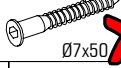
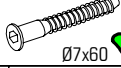

				
G	P	S	T	V
4x	4x	2x	1x	4x

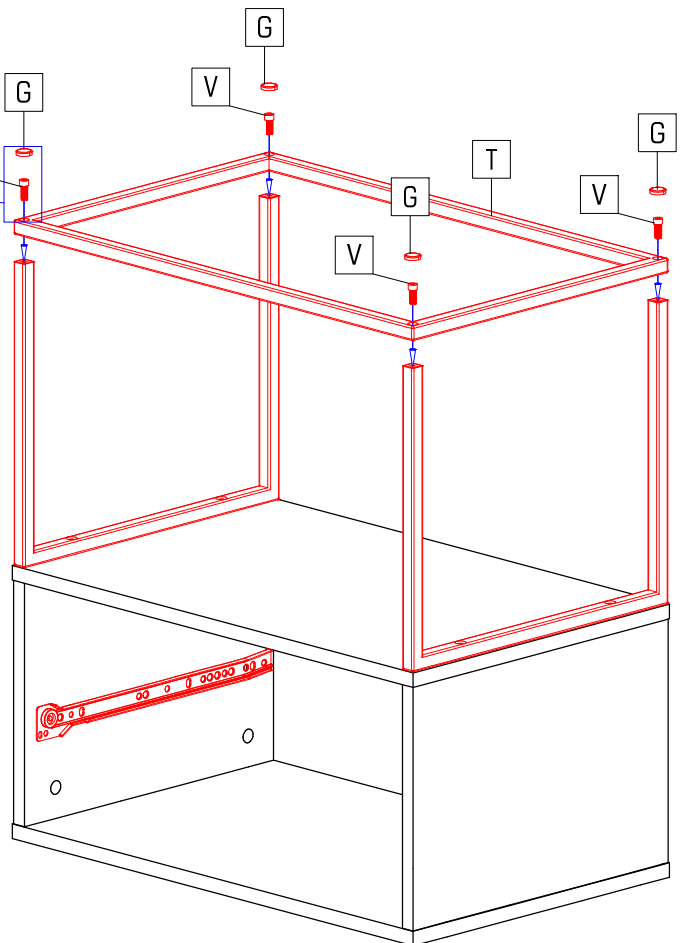
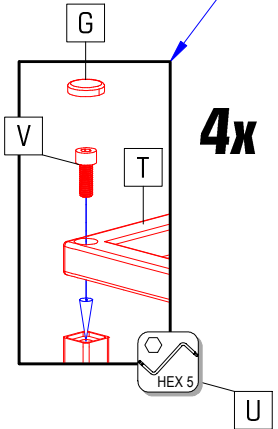
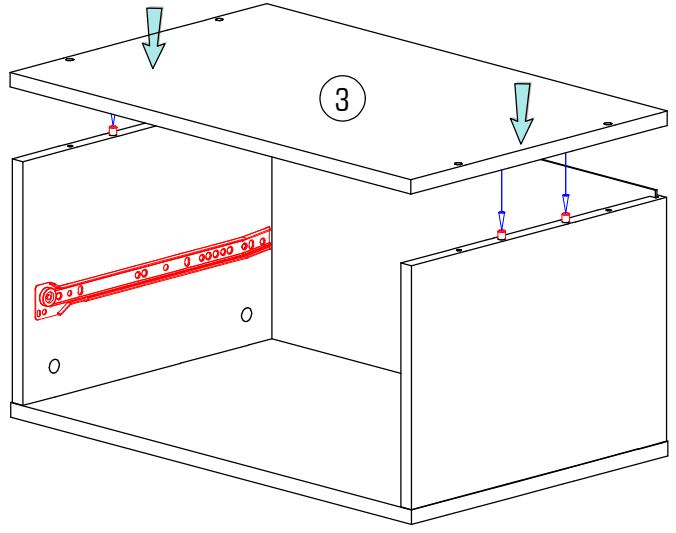
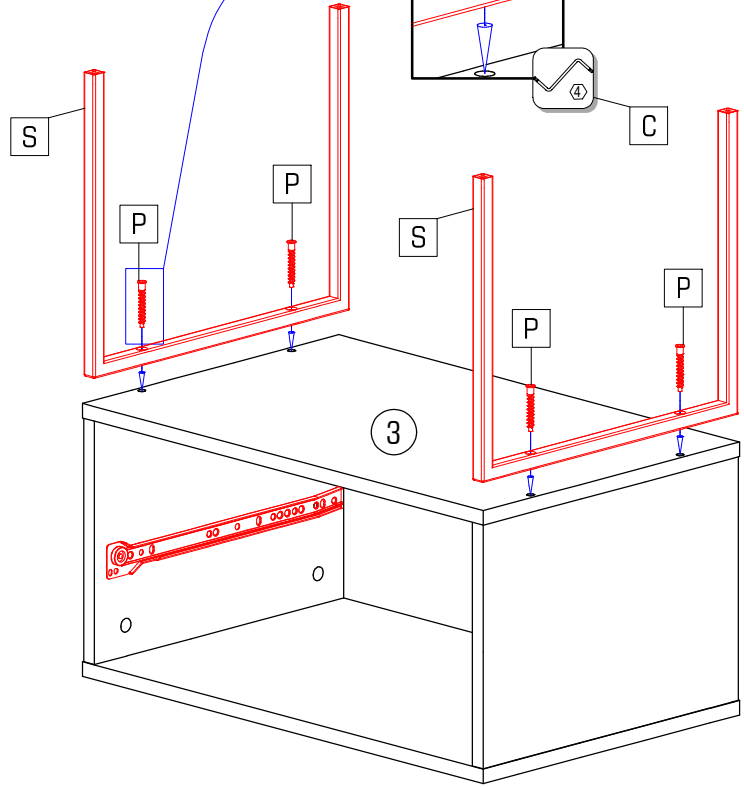

	
B	P
4x	4x

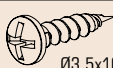

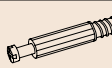
ARTI TYP 2 5/6

						
Ø7x50	Ø3,5x16	Ø3,5x15	Ø15x13			L=350
B 4x	D 6x	E 6x	K 4x	L 4x	M 4x	N 1x

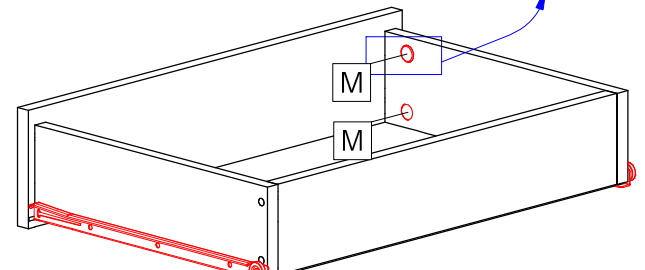
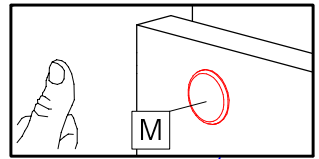
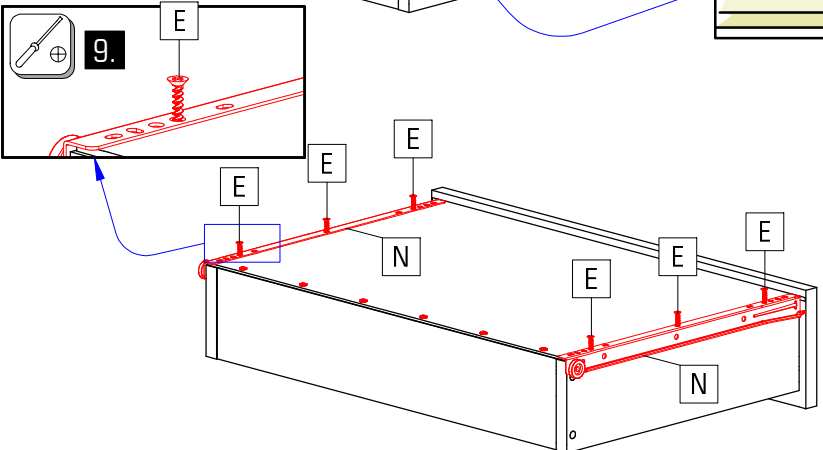
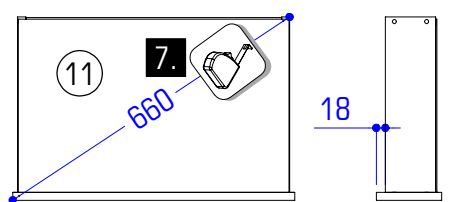
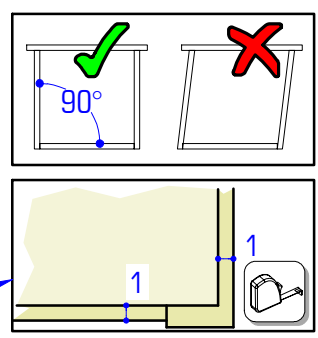
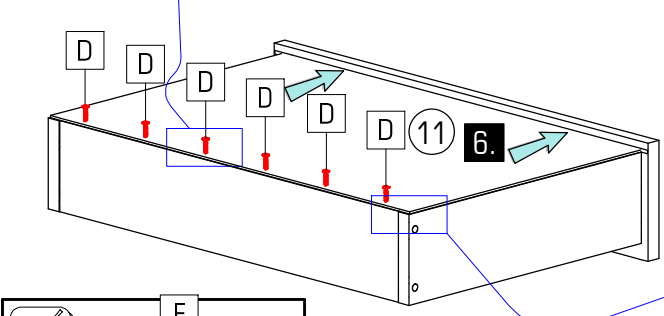
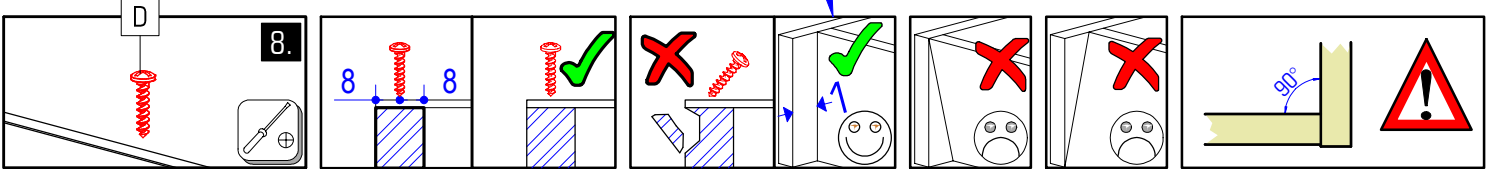
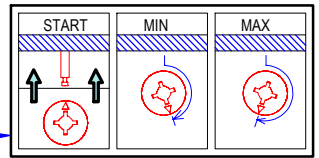
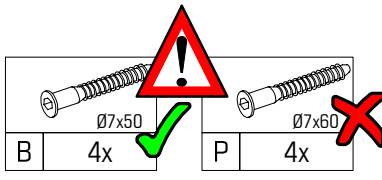
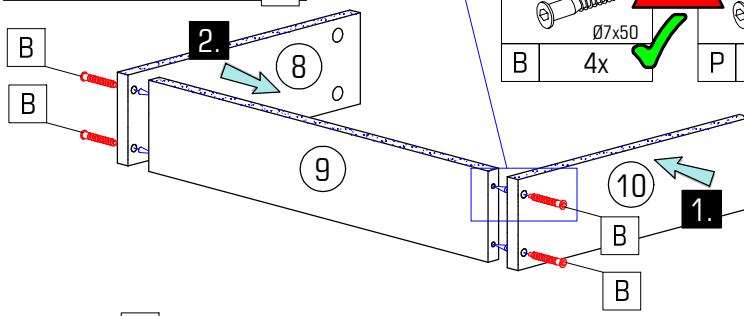
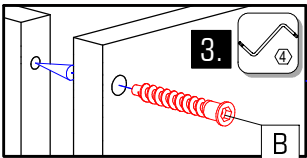
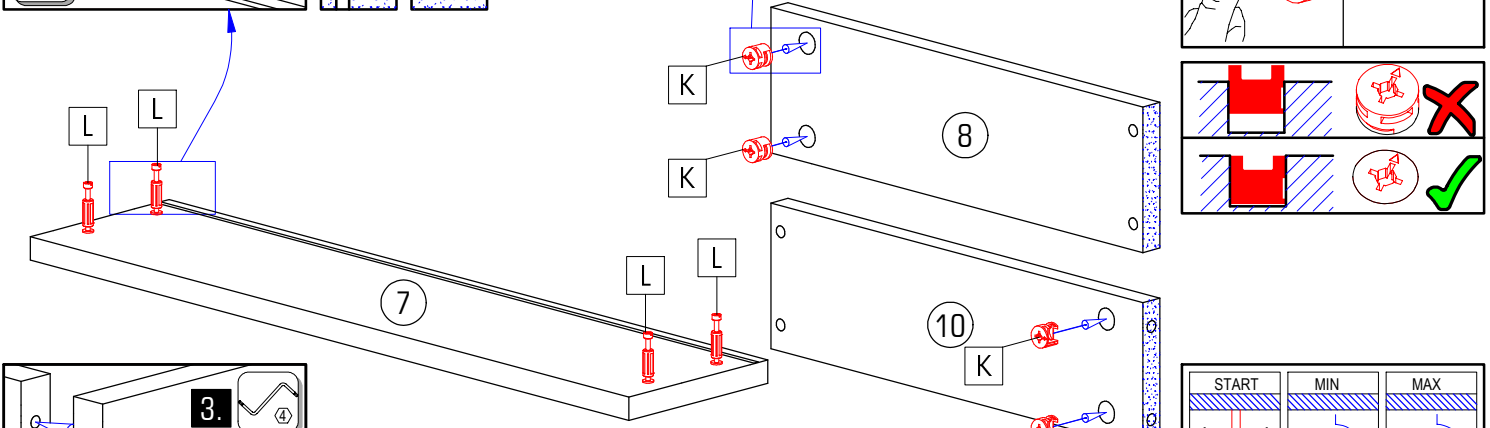
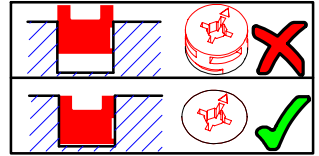
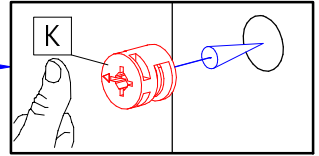
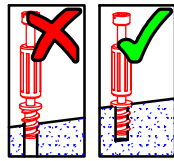
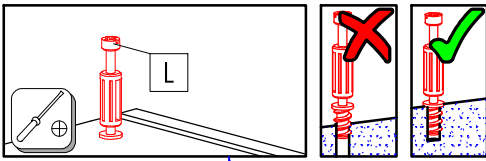
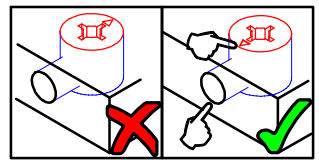

6/6 ARTI TYP 2

D 2x	H 1x	Q 1x	R 1x

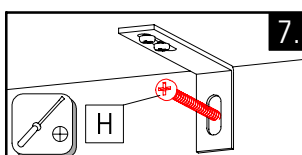
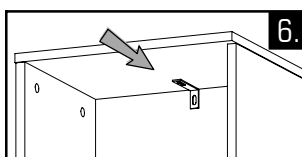
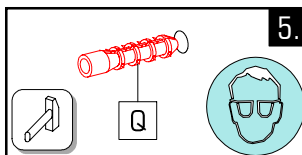
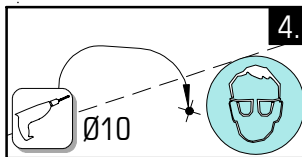
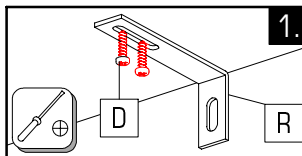
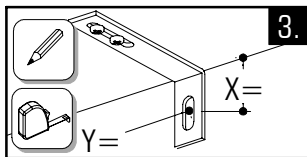
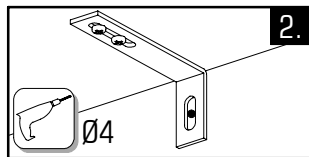

PL Uwaga! Ścianę należy sprawdzić przed montażem. Dolżzone uniwersalne kolki rozporowe są odpowiednie tylko do stosowania w mocnych murach, takich jak beton lub cegła. Nie rób z pomocą kółków ozporowych murowanych, takich jak pustak, lekka kostka, powierzchnie takie jak płyty gipsowo-kartonowe lub inne systemy ram. Jeśli dotyczy, muszą to być określone kolki rozporowe być użytymi! Są one dostępne w specjalistycznym sklepie niezgodność, producent / sprzedawca lub importer nie ponoszą odpowiedzialności.

DE Achtung! Die Wandbeschaffenheit ist vor der Montage unbedingt zu prüfen. Die beigelegten Universaldübel sind ausschließlich nur zur Verwendung für festes Mauerwerk wie Beton/Ziegel. Die Mauerdübel dürfen nicht bei Mauerwerk wie Hohlraumziegel, Leichtbausteinen, Gipskartonplatte oder anderer Rahmenbauweise verwendet werden. Bei diesen Mauerwerken sind gegebenenfalls Spezialdübel zu verwenden! Diese sind in einem Fachgeschäft erhältlich. Bei Nichtinhaltung wird seitens Produzenten/Händler und Importeur keine Haftung übernommen.

EN Caution! The wall must be examined before assembly. The included universal wall plugs are only suitable for using in firm masonry such as concrete block or brick. Do not use the wall plugs masonry such as hollow brick, lightweight block, surfaces such as gypsum plasterboard or other framing systems. If applicable, particular wall plugs must be used! These are available at a specialised store (hardware store). In case of non-compliance, the manufacturer/retailer or importer do not assume liability.

RO Prudență! Zidul trebuie examinat înainte de asamblare. Prizele de perete sunt adecvate numai pentru utilizarea în zidărie fermă, cum ar fi beton bloc sau cărămidă. Nu folosiți zidărie zidurilor de perete, cum ar fi cărămida goală, blocul ușor, suprafețe cum ar fi gips-carton sau altă încadrare sisteme. Dacă este cazul, trebuie folosite anumite prize de perete! Acestea sunt disponibile la un magazin specializat (magazin de hardware). În caz de nerespectare, producătorul / vânzătorul sau importatorul nu își asumă răspunderea.

HR Pažnja! Prije montaže obvezno provjerite svojstvo zida. Priložene univerzalne tiplje namijenjene su isključivo za masivne zidove od betona/opeke. Tiplje za masivne zidove ne smiju se koristiti za zidove kao npr. šupljina opeka laki sastavni elementi, gips-kartonske ploče ili drugi modularni načini gradnje. Za te zidove potrebne su eventualno posebne tiplje! Iste su dostupne u specijaliziranim trgovinama građevinskim materijalom. U slučaju nepridržavanja prethodno navedenih napomena, proizvođač/trgovac i uvoznik ne preuzimaju odgovornost!

CZ Upozornění! Před montáží je nutné zkontrolovat stav stěny. Přiložené univerzální hmoždinky jsou určeny pouze k použití pro pevné zdivo jako beton/cihly. Hmoždinky do zdi se nesmí používat u dutinová cihla, zdívka jako porovité stavební kámen, sádrokartonová deska nebo jiný měkký materiál. U těchto zdív jsou nutné použít speciální hmoždinky! Jsou k dostání v speciálních prodejních se stavebním materiálem. Při nedodržení těchto pokynů výrobce/prodejece a dovozce neručí za způsobené škody.

SI Pozor! Pred montažo preverite stanje stene. Priloženi univerzalni mozniki so izključno samo za uporabo na čvrstem zidovju, kot sta beton in opeka. Stenski mozniki se ne smejo uporabljati pri zidovju kot so votlina opeke, zidaki za lahko gradnjo, mavčne plošče ali druge okvirne gradnje. Pri teh zidovjih morate v danih primerih uporabljati posebne moznike. Ti so na voljo v specializiranih trgovinah (trgovinah z gradbenim materialom) Pri upoštevanju se s strani proizvajalca/trgovca in uvoznika ne prevzame jamstvo.

HU Vigyázat! Szerelés előtt a falfelületet feltétlenül vizsgálja meg. A mellékelt univerzális tiplje kizárólag stabil falazathoz használható mint például beton/tégla. A fal tiplje nem használható könnyű építőkövekhez, üreg tégla, gipszkarton lapokhoz vagy más fávázás építményekhez. Ezekhez a falfelületekhez csak speciális tiplik használhatóak, melyek szaküzletekben (barkácsáruházakban) beszerezhetőek. Fentiek figyelmen kívül hagyása esetén a gyártó/kereskedő vagy forgalmazó nem vállal felelősséget.

SK Upozornenie! Pevnosť steny sa musí pred montážou bezpodmienečne skontrolovať. Priložené univerzálne hmoždenky používajte jedine pre pevné murivo ako je betón/tehla. Hmoždenky sa nesmú používať v prípade ľahkého stavebného muriva, dutá tehla, Sádorkartónová doska, alebo iných konštrukcií rámu. U týchto stien je nutné použiť špeciálne hmoždenky! Tieto je možné dostať v špeciálnych predajniach so stavebným materiálom. Pri nedodržaní pokynov nepreberajú výrobcovia/predajci a dodávateľia zodpovednosť za vzniknuté škody.

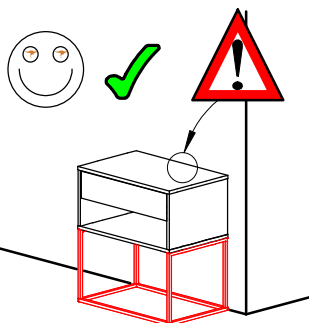
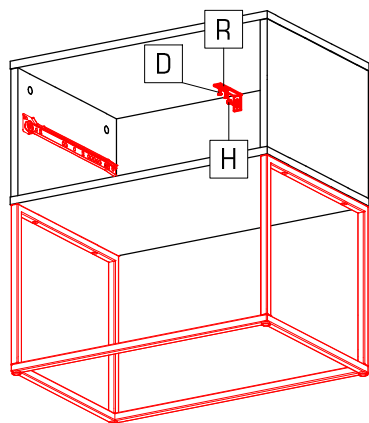

SK	VÝSTRAHA
CZ	VAROVÁNÍ
HR	UPOZORENIE
DE	WARNUNG
HU	FIGYELEM
PL	OSTRZEŻENIE
RO	AVERTIZARE
EN	WARNING
SI	OPOZORILO

